



Valena™

7700 66/67/68 - 7741 66/67/68 - 7702 66/67/68

**legrand**®

.... 66

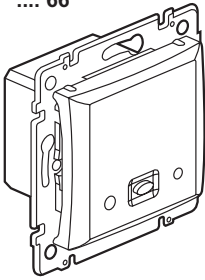

+

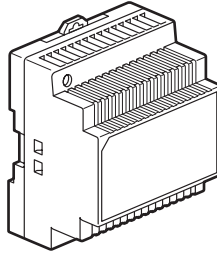

.... 67 + ... 68

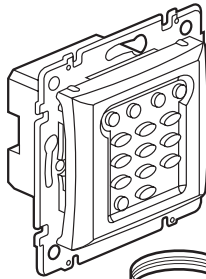
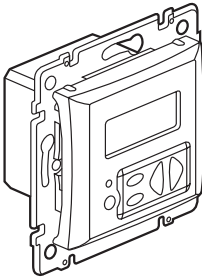

.... 67

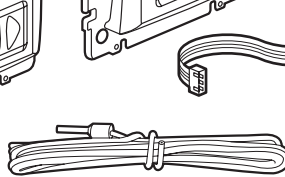
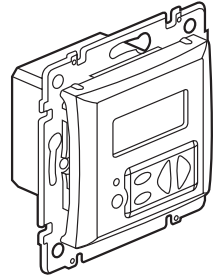

• 7742 23 / 7741 23  
7702 23

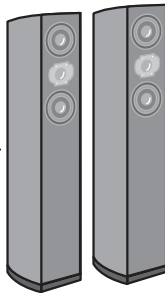
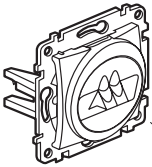

4/8/16 Ω

• 7744 24 / 7743 24  
7701 24

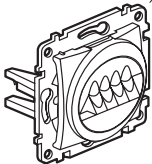

• 7700 65 / 71  
7741 65

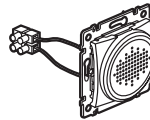

• 673 27

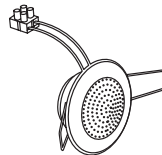

• 673 29

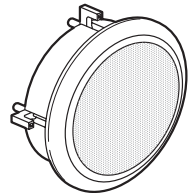

.... 67				
.... 67 + .... 68				

		$P_{OUT}$ 			$D_{max}$ 
	15	-	-	-	600
.... 66					
	15	Mono 1 x 1,5	-	-	600
.... 67		Stereo 2 x 1,5			
	15	Mono 1 x 1,5	87,5 MHz ↓ 108 MHz	20 max.	600
.... 67 + .... 68		Stereo 2 x 1,5			

**7700 66**

	Stereo			Mono		
	Min	Norm	Max	Min	Norm	Max
7700 67	1,2	2,1	4,4	1,2	1,7	2,8
7700 67 + 7700 68	1,5	2,8	5,3	1,5	2,2	3,4
7700 66	1,1	1,5	1,5	1,1	1,5	1,5

60 W  
15 ---

P<sub>1</sub> 1,5 W      P<sub>2</sub> 2,1 W      P<sub>3</sub> 2,8 W      P<sub>n</sub> 2,1 W

.... 66      .... 67      .... 67 + .... 68      .... 67

$P_1 + P_2 + P_3 + \dots + P_n \leq 60 \text{ Watts}$

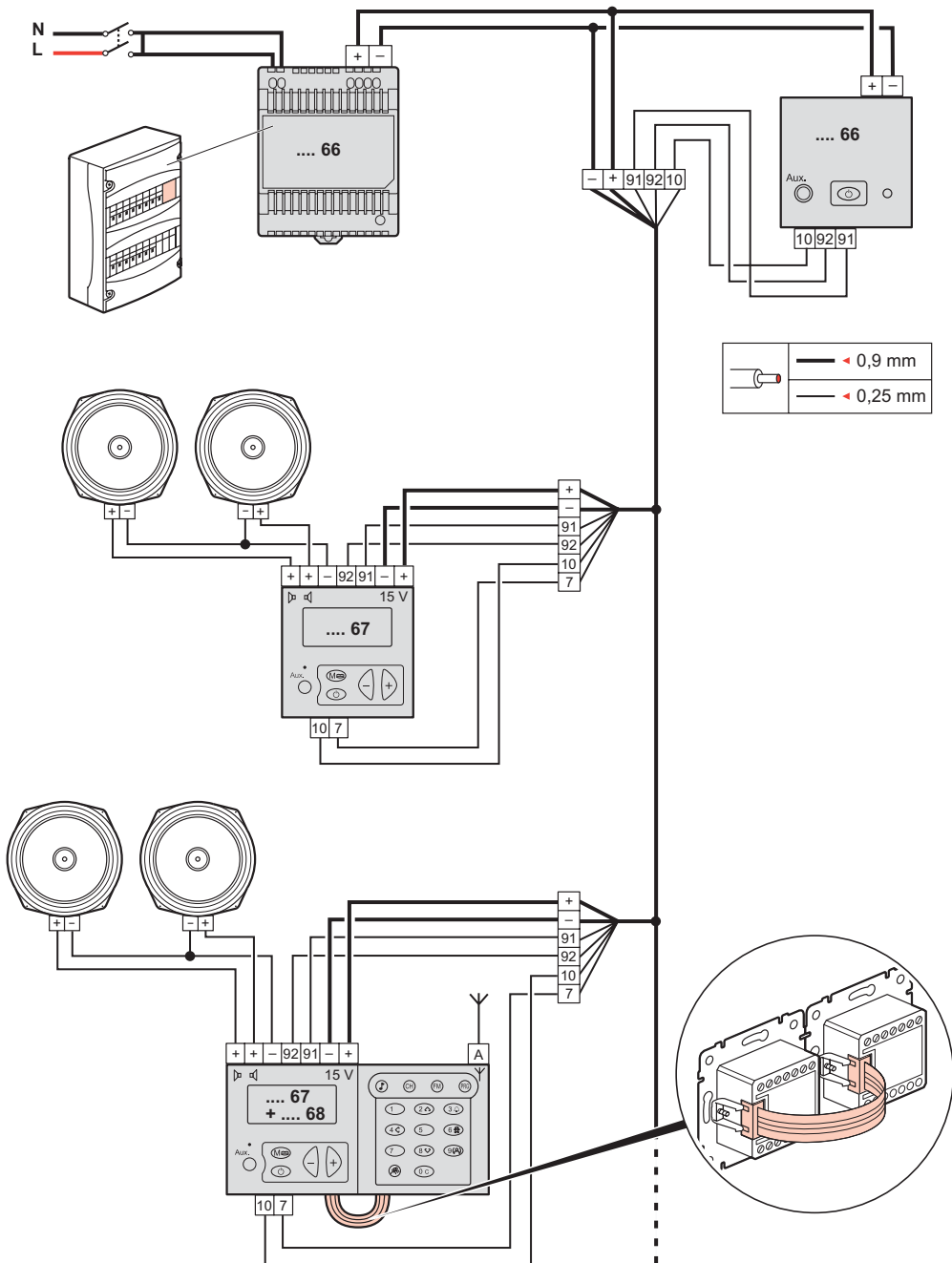

ВСЕПОЛЮСНЫЙ СЕТЕВОЙ ВЫКЛЮЧАТЕЛЬ с контактами, разделенными по крайней мере промежутком, равным 3 мм в каждом полюсе, должен быть установлен в систему энергоснабжения здания

.... 66

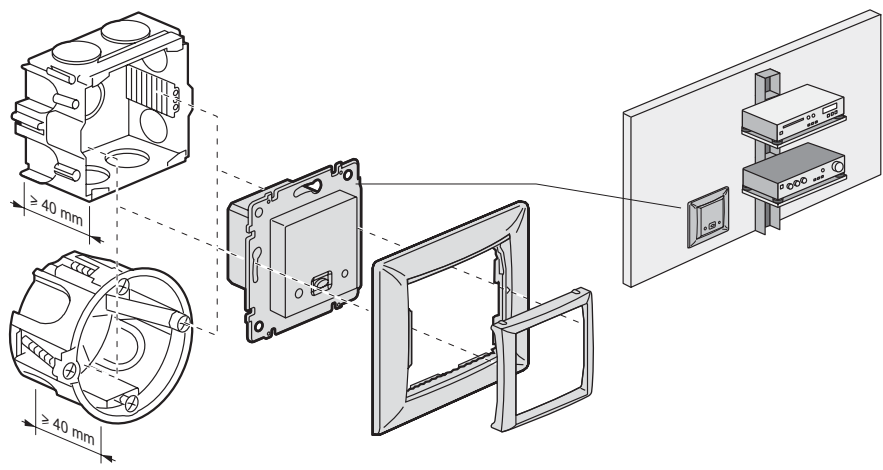

.... 67

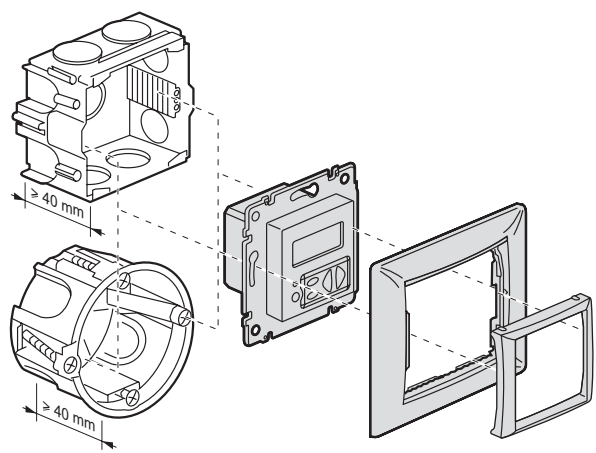

.... 67 + .... 68

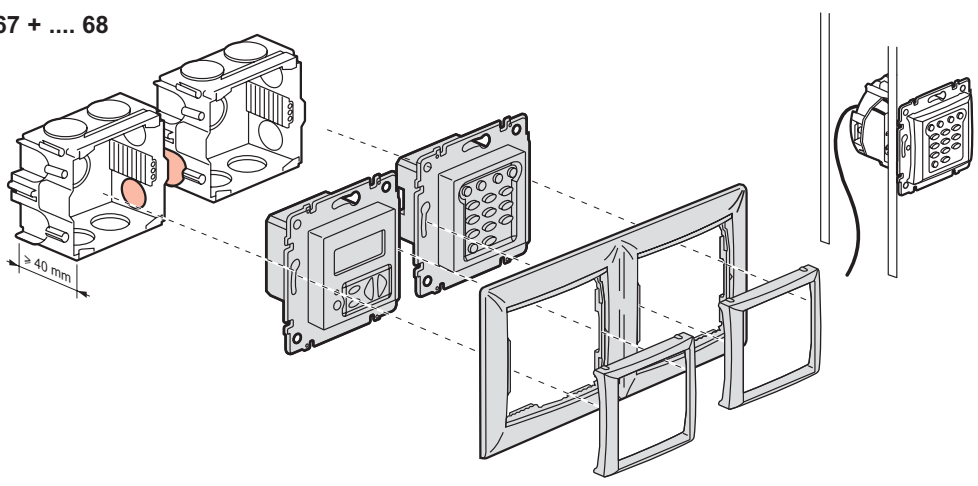

- Activating a system using a local control
- Colocação em funcionamento de um sistema com comando local
- Θέση σε λειτουργία συστήματος με ξεχωριστό έλεγχο
- Puesta en marcha de un sistema con mando local
- Helyi vezérlésű rendszer üzembe helyezése

- Bir sistemin yerel kumanda ile çalıştırılması
- Spuštění systému s lokálním ovládním
- Запуск системы с локальным управлением
- Zapnutie systému miestnym ovládačom
- Uruchomienie systemu ze sterowaniem lokalnym
- Mise en route d'un système avec commande locale

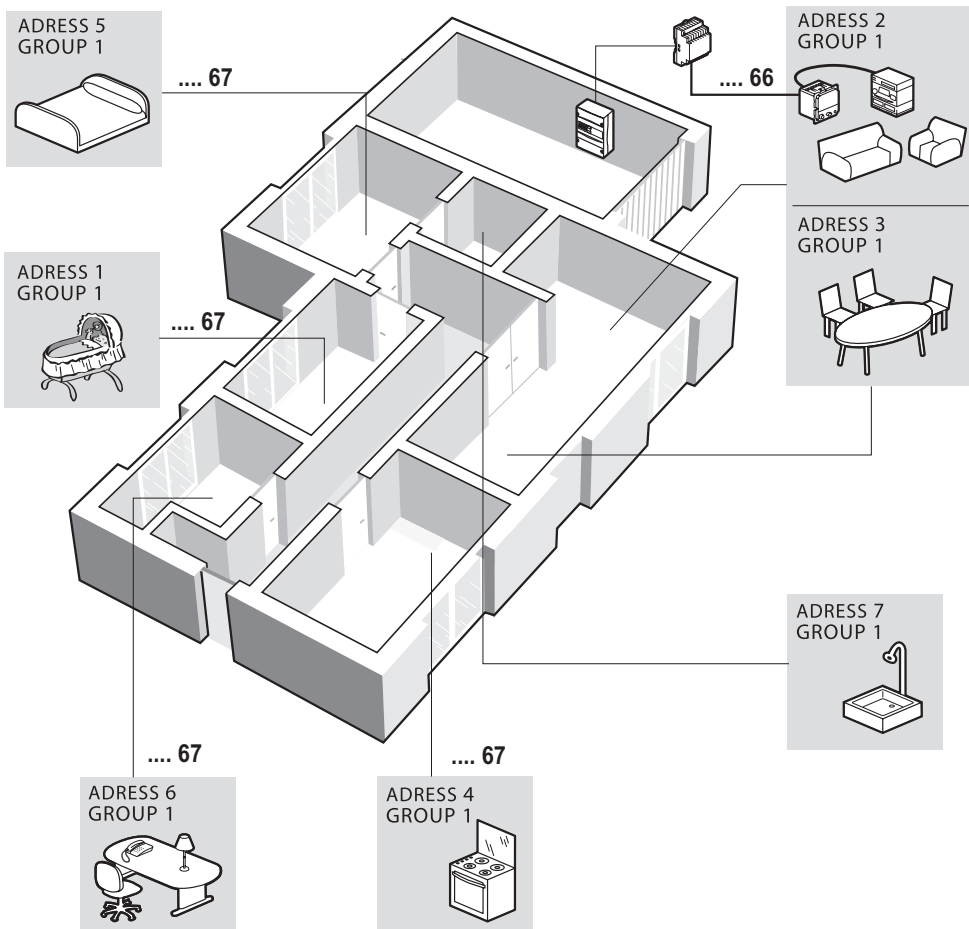
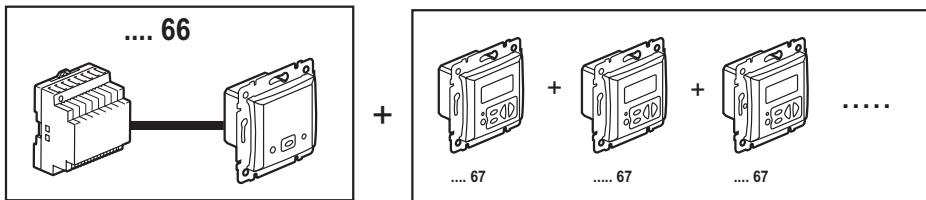

- Zone
- Zona

- Ζώνη
- Zona

- Zóna
- Bölge

- Zóna
- Зона

- Zóna
- Strefa

- Zone

ADDRESS = X1



ADDRESS 1

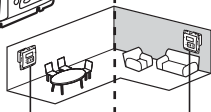

ADDRESS 2

ADDRESS 3



= adresa 1



= adresa 2



= ~~adresa 2~~ = adresa 3

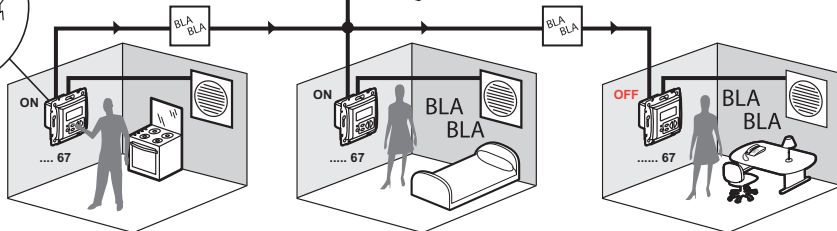
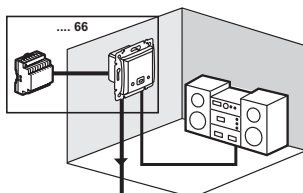
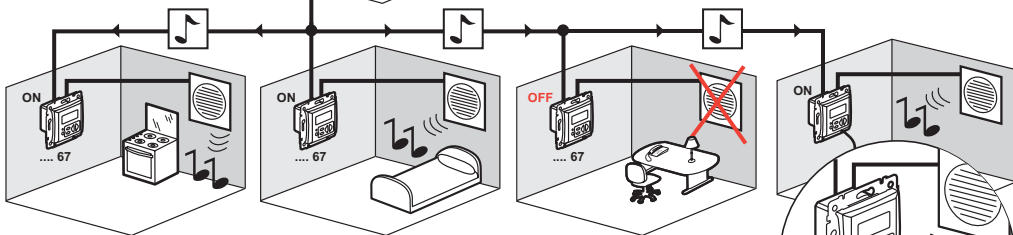
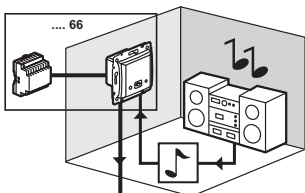



- Operation to be performed on all products
- Operação a realizar em todos os produtos
- Ενέργεια που πρέπει να πραγματοποιηθεί σε όλα τα προϊόντα
- Operación que se debe realizar en todos los productos
- Minden termékén elvégzendő művelet
- Bütün ürünler üzerinde gerçekleştirilecek işlem
- Operace se provede na všech výrobcích
- Операция выполняется на всех устройствах
- Úkon, ktorý sa má urobiť na všetkých výrobkoch
- Operacja wykonywana na wszystkich produktach
- Opération à réaliser sur tous les produits

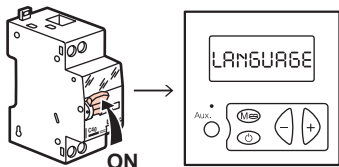

1

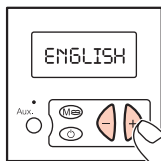

1. ENGLISH
2. PORTUGUESE
3. NEDERLANDS
4. FRANÇAIS
5. DEUTCH
6. ESPAÑOL

2

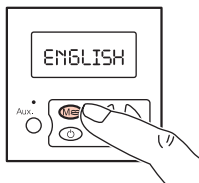

3

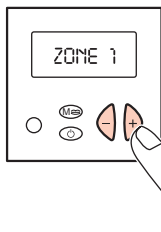

- ZONE 1  
ZONE 2  
...

4

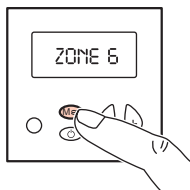

5

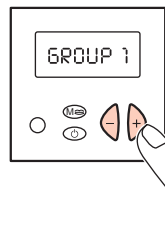

- GROUP 1  
GROUP 2  
...

6

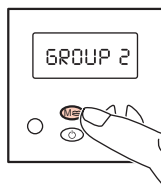

"GRUPE ..."

- function deactivated in this configuration
- Função não activa nesta configuração
- λειτουργία μη ενεργή στη διαμόρφωση αυτή
- Función no activa en esta configuración
- Ebben a konfigurációban nem aktív funkció
- Bu biçimde aktif olmayan fonksiyon
- Funkce v této konfiguraci není aktivní
- В этой конфигурации функция не активна
- Funkcia nie je aktivovaná v tejto konfigurácii
- funkcja nieaktywna w tej konfiguracji
- Fonction non active dans cette configuration



- Setting the time: operation to be performed on just one product
- Acertar a hora: operação a realizar num único produto
- Ρύθμιση της ώρας: ενέργεια που πρέπει να πραγματοποιηθεί σε ένα μόνο προϊόν
- Puesta a la hora: operación que se debe realizar en un solo producto
- Óra beállitás: egyetlen termékén elvégzendő művelet
- Saatin ayarlanmas: tek bir ürün üzerinde gerçekleştirilecek iflem
- Nastavení hodin: Operace se provede na jediném výrobku
- Nastavenie času: Ёkon, ktorý sa má urobiť na jednom výrobku
- Ёkon, ktorý sa má urobiť na všetkých výrobkoch
- Ustawienie godziny: operacja wykonywana tylko na jednym produkcie
- Mise à l'heure : opération à réaliser sur un seul produit



1

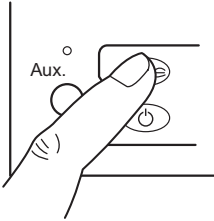

2

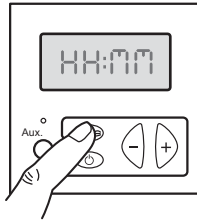

> 1 sec

3

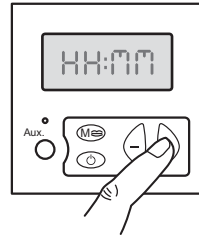

4

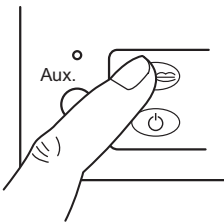

5

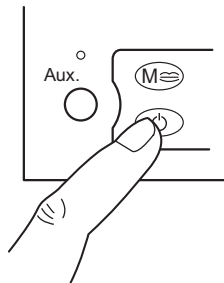



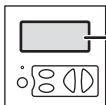

OFF

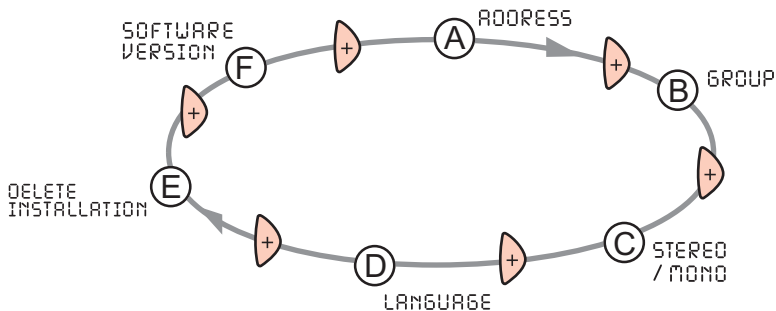
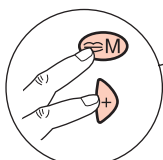
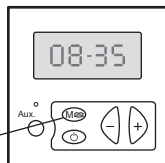

- (A)**
- Zone change
  - Modificação de zona
  - Τροποποίηση ζώνης
  - Modificación de zona

- Zóna módositása
- Bölgenin değiştirilmesi
- Změna zóny
- Изменение зоны

- Modifikácia zóny
- Zmiana strefy
- Modification de zone



ADDRESS = ZONE

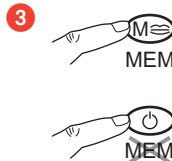
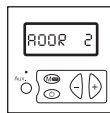

- (B)**
- Group change
  - Modificação de grupo
  - Τροποποίηση ομάδας
  - Modificación de grupo

- Csoport módositása
- Grubun değiştirilmesi
- Změna skupiny
- Изменение группы

- Modifikácia skupiny
- Zmiana grupy
- Modification de groupe

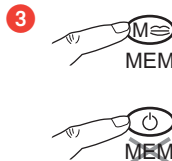
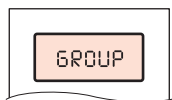

- C**
- Mono/stereo selection
  - Selecção mono / estéreo
  - Επιλογή μονοφωνικό / στερεοφωνικό
  - Selección mono / estéreo

- Mono / sztereó mód kiválasztása
- Mono / stereo seçimi
- Volba mono / stereo
- Выбор моно/стерео

- Vofba mono/stereo
- Wybór mono/stereo
- Sélection mono / stéréo

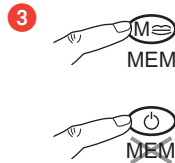
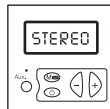
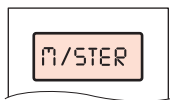

- D**
- Choice of the language
  - Escolha do idioma
  - Επιλογή της γλώσσας
  - Selección del idioma

- Nyelv kiválasztása
- Dil seçimi
- Volba jazyka
- Выбор языка

- Výber jazyka
- Wybór języka
- Choix de la langue

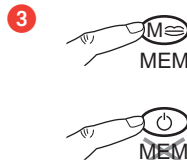
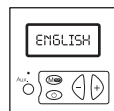
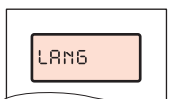

1. ENGLISH
2. ESPAÑOL
3. DEUTSCH
4. FRANÇAIS
5. NEDERLANDS
6. PORTUGUESE

- E**
- Delete installation
  - Supressão instalação
  - Κατάργηση εγκατάστασης
  - Supresión de la instalación

- Berendezés törlése
- Kurulumun iptali
- Zrušení instalace
- Удаление установки

- Vymazanie inštalácie
- Anulowanie instalacji
- Suppression installation

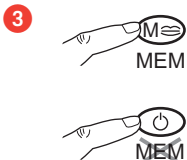
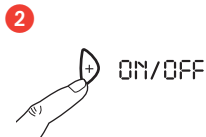
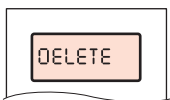

- F**
- Software version
  - Versão do software
  - Έκδοση του λογισμικού
  - Versión del software

- Szoftver verziója
- Yazılımın versiyonu
- Verze softwaru
- Версия программного обеспечения

- Verzia programu
- Wersja oprogramowania
- Version du logiciel

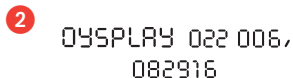
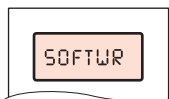

- Activating a system using a local control + local tuner
- Colocação em funcionamento de um sistema com comando local + tuner local
- Θέση σε λειτουργία ενός συστήματος με ξεχωριστό έλεγχο + ξεχωριστό tuner
- Puesta en marcha de un sistema con mando local + sintonizador local
- Helyi vezérlésű + helyi tunerrel felszerelt rendszer beüzemelése
- Bir sistemin yerel kumanda + yerel radyo ile çalıştırılması
- Spuštění systému s lokálním ovládáním + lokálním tunerem
- Запуск системы с локальным управлением + локальным тюнером
- Zapnutie systému miestnym ovládačom + miestny volič kanálov
- Uručenie systému ze sterowaniem lokalnym + lokalnym tunerem
- Mise en route d'un système avec commande locale + tuner local

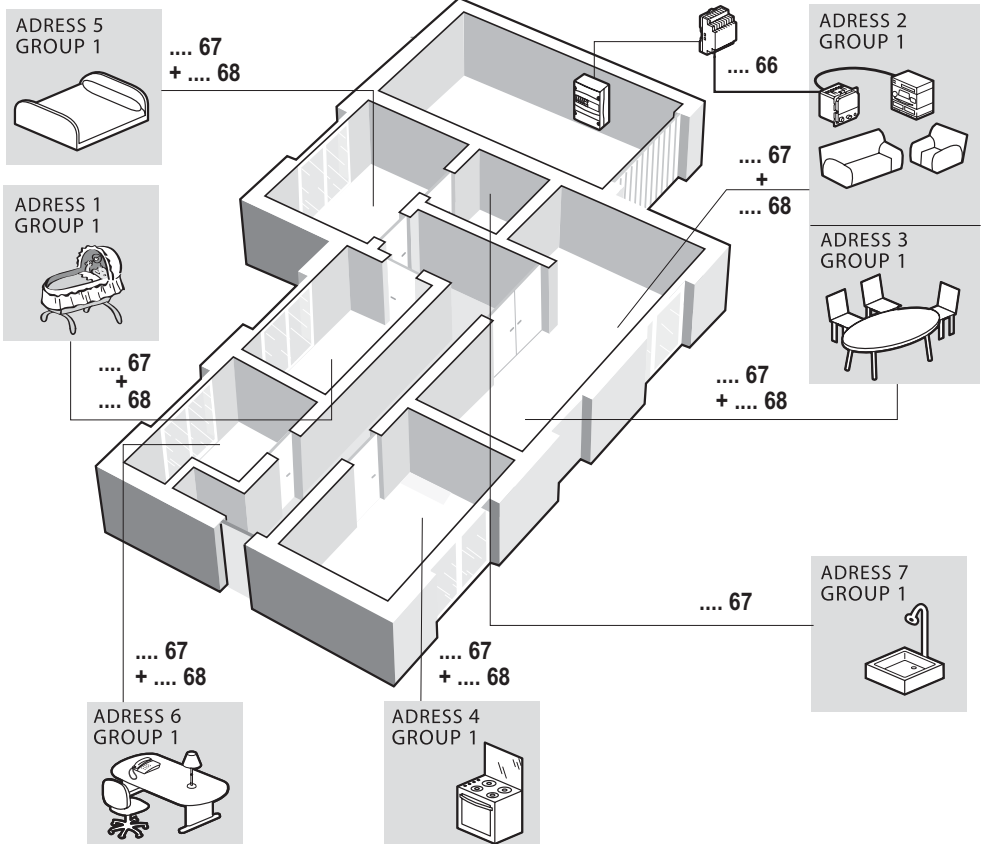
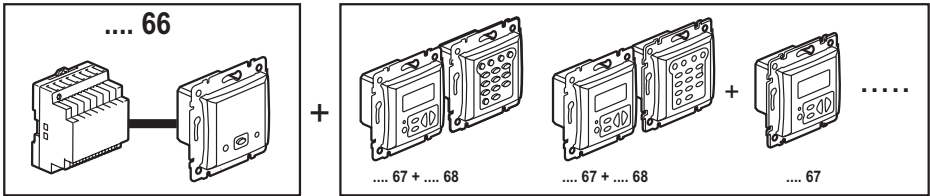

• Zone  
• Zona

• Ζώνη  
• Zona

• Zóna  
• Bölge

• Zóna  
• Зона

• Zóna  
• Strefa

• Zone

ADDRESS =  x 1 /  x 1



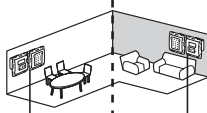

ADDRESS 1







ADDRESS 2

ADDRESS 3



 /  = adress 1

 /  = adress 2

 /  = ~~adress 2~~ = adress 3

• Group  
• Grupo



• Ομάδα  
• Grupo

• Csoport  
• Grup

• Skupina  
• Γρυνπα

• Skupina  
• Grupa

• Groupe

GROUP =  +  +  + ...

GROUP 1 = (address 1 + address 2 + address 3 + address 4)

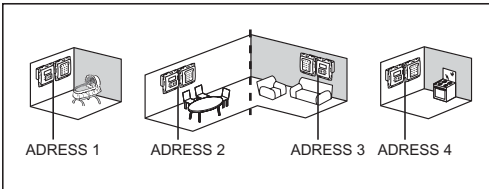

ADDRESS 1

ADDRESS 2

ADDRESS 3

ADDRESS 4

GROUP 2 = (address 5 + address 6)

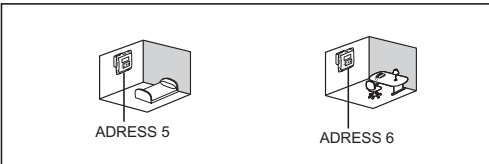

ADDRESS 5

ADDRESS 6

GROUP 3 = (address 7)

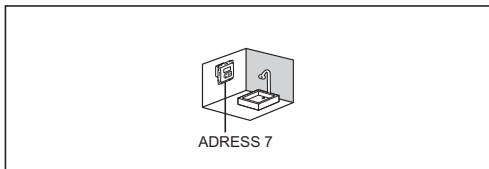



ADDRESS 7



GROUP 1

 = adress 1

+  
 = adress 2

+  
 = adress 3

+  
 = ~~adress 3~~ = adress 4

GROUP 2

 = adress 5

+  
 = ~~adress 5~~ = adress 6

GROUP 3

 = ~~adress 6~~ = adress 7

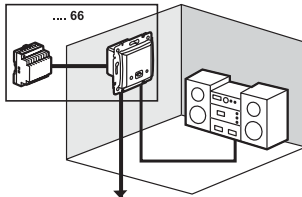
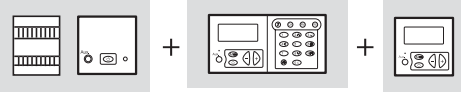

### GROUP 1

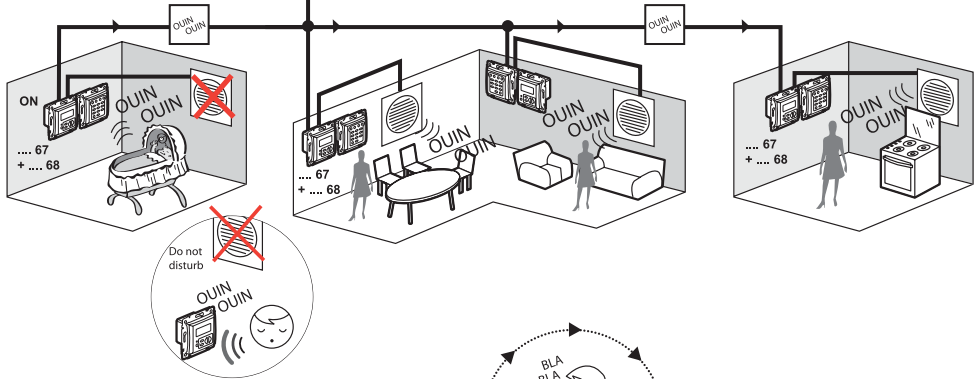

### GROUP 2

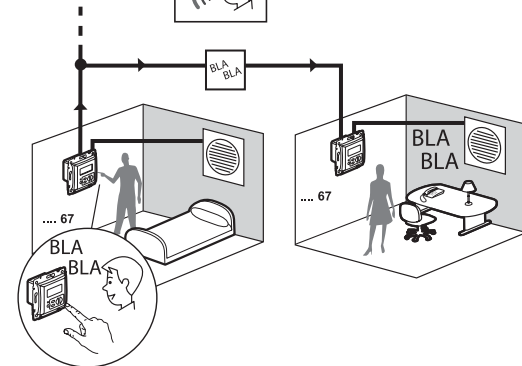

### GROUP 3

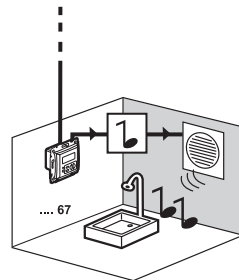

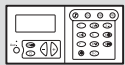

- Operation to be performed on all products
- Operação a realizar em todos os produtos
- Ενέργεια που πρέπει να πραγματοποιηθεί σε όλα τα προϊόντα
- Operación que se debe realizar en todos los productos
- Minden termékén elvégzendő művelet
- Bütün ürünler üzerinde gerçekleştirilecek işlem
- Operace se provede na všech výrobcích
- Операция выполняется на всех устройствах
- Úkon, ktorý sa má urobiť na všetkých výrobkoch
- Operacja wykonywana na wszystkich produktach
- Opération à réaliser sur tous les produits

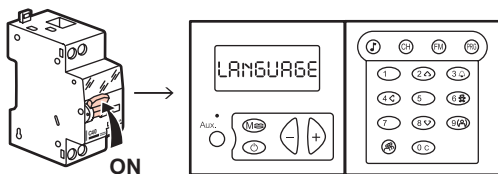

ON

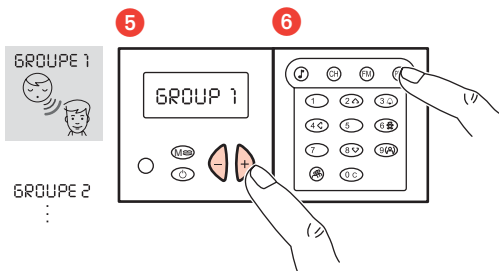
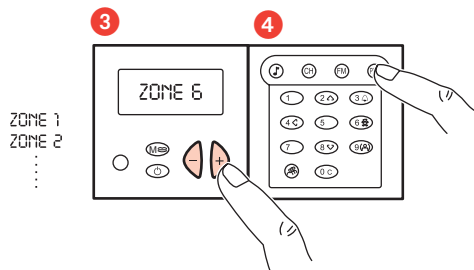
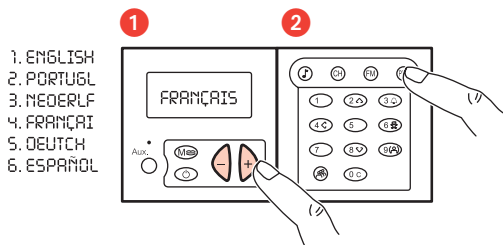



- Setting the time: operation to be performed on just one product
- Acertar a hora: operação a realizar num único produto
- Ρύθμιση της ώρας: ενέργεια που πρέπει να πραγματοποιηθεί σε ένα μόνο προϊόν
- Puesta a la hora: operación que se debe realizar en un solo producto
- Óra beállitása: egyetlen terméken elvégzendő művelet
- Saatın ayarlanması: tek bir ürün üzerinde gerçekleştirilecek işlem
- Nastavení hodin: Operace se provede na jediném výrobku
- Nastavenie času: Ёкон, котора са m3 urobiť na jednom виробку
- Ёкон, котора са ма urobiť na všetkých виробках
- Ustawienie godziny: operacja wykonywana tylko na jednym produkcie
- Mise à l'heure : opération à réaliser sur un seul produit

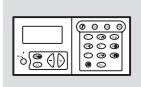

1

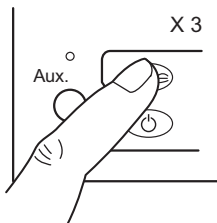

2

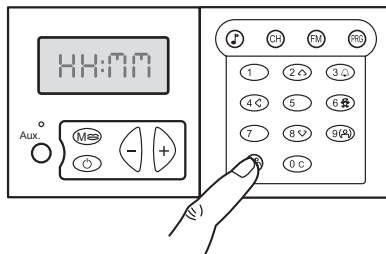

4

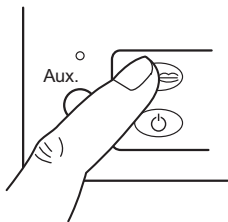

5

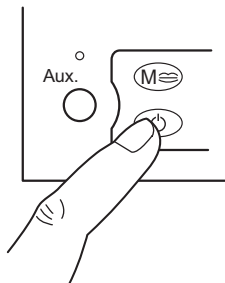

## FM → MEM AUTO

- Operation to be performed on all products (scan and automatic memorizing)
- Operação a realizar em todos os produtos (scan e memorização automática)
- Ενέργεια που πρέπει να πραγματοποιηθεί σε όλα τα προϊόντα (scan και αυτόματη αποθήκευση)
- Operación que se debe realizar en todos los productos (escán y memorización automática)
- Minden termékén elvégzendő művelet (pászta-zás és automatikus mentés)
- Bütün ürünler üzerinde gerçekleştirilecek işlem (otomatik tarama ve hafızaya alma)
- Operace se provede na všech výrobcích (automatické vyhledání a uložení do paměti)
- Операция выполняется на всех устройствах (сканирование и автоматическое запоминание)
- Úkon, ktorý sa má urobiť na všetkých výrobkoch (skenovanie a uloženie do automatickej pamäte)
- Operacja wykonywana na wszystkich produktach (przeszukiwanie i automatyczne zapamiętywanie)
- Opération à réaliser sur tous les produits (scan et mise en mémoire automatique)

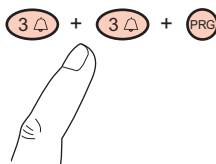
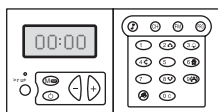

- If there is still poor reception, refer to page 10 of the user guide
- Se a má recepção persistir, ver página 10 do manual utilizador
- Αν εξακολουθεί η κακή λήψη βλέπε σελίδα 10 του εγχειριδίου χρήσης
- Si persiste la mala recepción, ver página 10 del manual del usuario
- Ha a vétel rossz marad, lásd a felhasználói kézikönyv 10. oldalát
- Eğer kötü alış devam ediyorsa kullanıcı kılavuzunun 10. sayfasına bakınız
- Jestliže je příjem i nadále nekvalitní, viz strana 10 uživatelské příručky
- При плохом приеме см. стр. 10 инструкции пользователя
- Ak je príjem stále zlý, pozri stranu 10 v príručke užívateľa
- Jeśli odbiór nadal jest zły, patrz strona 10 instrukcji użytkownika
- Si la mauvaise réception persiste voir page 10 de la notice utilisateur

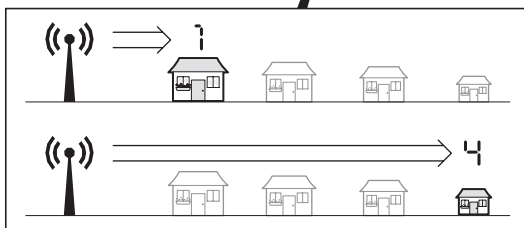
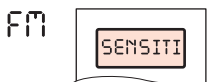



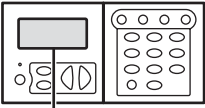

OFF

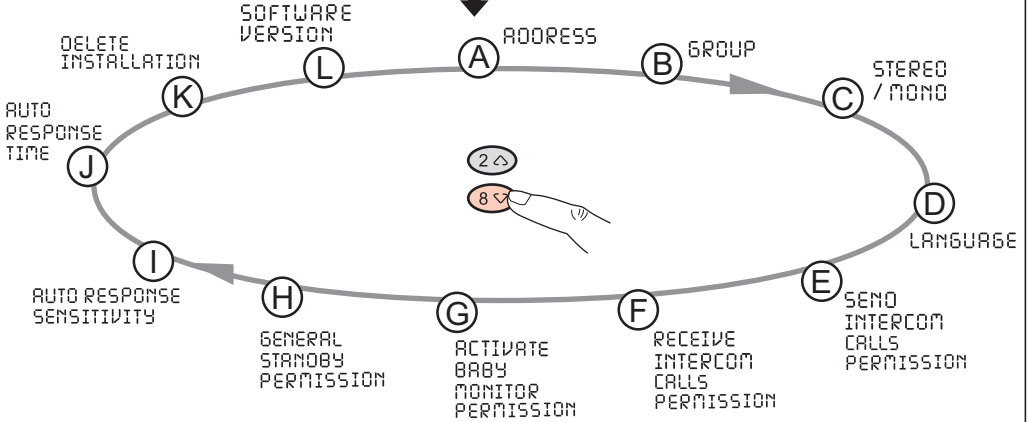
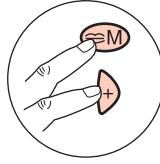
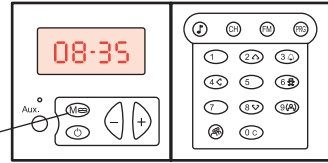

- A**
- Zone change
  - Modificação de zona
  - Τροποποίηση ζώνης
  - Modificación de zona

- Zóna módosítása
- Bölgenin değiştirilmesi
- Změna zóny
- Изменение зоны

- Modifikácia zóny
- Zmiana strefy
- Modification de zone



ADDRESS = ZONE



- B**
- Group change
  - Modificação de grupo
  - Τροποποίηση ομάδας
  - Modificación de grupo

- Csoport módosítása
- Grubun değiştirilmesi
- Změna skupiny
- Изменение группы

- Modifikácia skupiny
- Zmiana grupy
- Modification de groupe

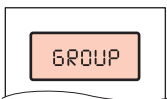

- C**
- Mono/stereo selection
  - Seleção mono / estéreo
  - Επιλογή μονοφωνικό / στερεοφωνικό
  - Selección mono / estéreo
  - Mono / sztereó mód kiválasztása
  - Mono / stereo seçimi
  - Volba mono / stereo
  - Выбор моно/стерео
  - Volba mono/stereo
  - Wybór mono/stereo
  - Sélection mono / stéréo

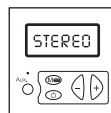
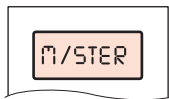

- D**
- Choice of the language
  - Escolha do idioma
  - Επιλογή της γλώσσας
  - Selección del idioma
  - Nyelv kiválasztása
  - Dil seçimi
  - Volba jazyka
  - Выбор языка
  - Výchber jazyka
  - Wybór języka
  - Choix de la langue

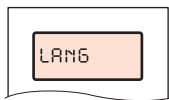

1. ENGLISH
2. ESPAÑOL
3. DEUTSCH
4. FRANÇAIS
5. NEDERLANDS
6. PORTUGUESE

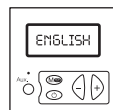

- E**
- 'Send intercom calls' permission
  - Autorização envio chamadas
  - Επιτρέπεται η αποστολή κλήσεων
  - Autorización de envío de llamadas
  - Híváskezdeményezés engedélyezése
  - Çağrı gönderim izni
  - Odesílané volání povoleno
  - Разрешить отправлять вызовы
  - Povolenie na posielanie volaní
  - Autoryzacja - wywoływanie rozmów
  - Authorisation envoi appels

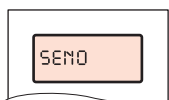

- F**
- 'Receive intercom calls' permission
  - Autorização recepção chamadas
  - Επιτρέπεται η λήψη κλήσεων
  - Autorización de recepción de llamadas
  - Hívásfogadás engedélyezése
  - Çağrı alma izni
  - Příjem volání povolen
  - Разрешить принимать вызовы
  - Povolenie na prijímanie volaní
  - Autoryzacja - odbieranie rozmów
  - Authorisation réception appels

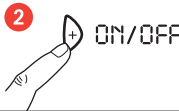
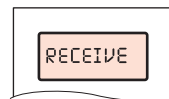

- F**
- Activate baby monitor
  - Ativação babyphone
  - Ενεργοποίηση babyphone
  - Activación del babyphone
  - Babatelefon aktiválása
  - Babyphone etkinleştirilmesi
  - Aktivace elektronické chůvy
  - Включение модуля наблюдения за ребенком
  - Aktivácia babyfonu
  - Aktywacja babyfonu
  - Activation babyphone

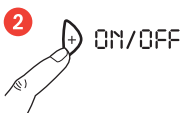
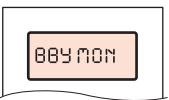

- H**
- General standby
  - Standby geral
  - Γενική θέση σε κατάσταση αναμονής
  - Puesta en espera general
  - Általános készenléti üzemmódba állítás
  - Genel bekleme moduna alma
  - Celkový úsporný režim (standby)
  - Общее включение
  - Uvedenie celého zariadenia do pohotovostného režimu
  - Tryb czuwania na poziomie ogólnym
  - Mise en veille générale

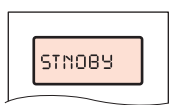

- I**
- Setting auto-response sensitivity
  - Ajuste sensibilidade auto-resposta
  - Ρύθμιση της ευαισθησίας της αυτόματης απάντησης
  - Ajuste de la sensibilidad de respuesta automática
  - Automatikus válasz érzékenységének beállítása
  - Otomatik cevaplama hassasiyet ayarı
  - Nastavení citlivosti automatické odpovědi
  - Регулировка чувствительности автоответа
  - Nastavenie citlivosti auto-odpovede
  - Regulacja czułości autorespondera
  - Réglage sensibilité auto-réponse

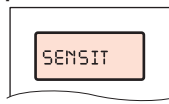

- J**
- Setting auto-response time
  - Ajuste tempo auto-resposta
  - Ρύθμιση του χρόνου αυτόματης απάντησης
  - Ajuste del tiempo de respuesta automática
  - Automatikus válasz idejének beállítása
  - Otomatik cevaplama zaman ayarı
  - Nastavení času automatické odpovědi
  - Регулировка времени автоответа
  - Nastavenie doby auto-odpovede
  - Regulacja czasu autorespondera
  - Réglage temps auto-réponse

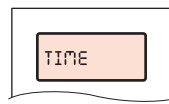

- K**
- Delete installation
  - Supressão instalação
  - Κατάργηση εγκατάστασης
  - Supresión de la instalación
  - Berendezés törlése
  - Kurulumun iptali
  - Zrušení instalace
  - Удаление установки
  - Vymazanie inštalácie
  - Anulowanie instalacji
  - Suppression installation

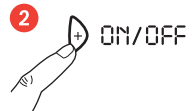

- L**
- Software version
  - Versão do software
  - Έκδοση του λογισμικού
  - Versión del software
  - Szoftver verziója
  - Yazılımın versiyonu
  - Verze softwaru
  - Версия программного обеспечения
  - Verzia programu
  - Wersja oprogramowania
  - Version du logiciel

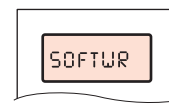

2 AFFICHAGE 022 006,  
082916 CLAVIER,  
VER 1.3

